



**PROVISIONAL OPERATION AND SERVICING
MANUAL
TO THE
WALTHER**

SUB-MACHINE GUN 9x19 mm WITH FOLDING STOCK

MODEL L & MODEL S
(long) (short)

CARL WALTHER-WAFFENFABRIK-ULM/DONAU



-MP

I N D E X

<u>Description</u>	Page	Illustration
Foreword	3	
Index to Illustrations	4	
WALTHER MP, long model, short model	5	1 & 2
Technical Data	6	
Special characteristics	7	
Layout diagram	8	3
Arrangement of coarse and precision sights	9	4
Survey of action and trigger mechanism	10	5
<u>Operation</u>		
Prefatory Notice	11	
Applying the Safety device	11	6
Change-over from "Safe" to "Automatic Fire"	11	7a
Change-over from "Safe" to "Single Shot"	11	7b
Folding Stock, extended	11	8
Folding Stock, folded up	11	9
Filling the magazine	12	10
Emptying the magazine	12	
Preparing to fire	12	
Inserting the magazine	12	11
Cocking the action	12	12
Bolt safety device	13	13
Shooting	13	14
Continuous Fire	13	
Short bursts	13	
Single shots	13	
Change of magazines	13	15
Un-cocking the action	14	16
Firing with blank ammunition	14	17
"Shake-Through" to clear action	14	18
Dismantling the MP for cleaning	15	
Preparing to dismantle	15	
Removing the connecting pin	15	19 & 20
Dismantling the action body	15	21 & 22
Dismantling the action (bolt)	16	23
Dismantling the spring guide rod	16	24 & 25
Dismantling the barrel	16	26 & 27
Survey of dismantled parts	17	28
Cleaning	17	
Assembling the dismantled components	18	
Prefatory Note relating to Assembly	18	
Mounting the barrel	18	27
Assembling the spring guide rod	18	25
Assembling the action (bolt)	18	23
Assembling the action body	19	21 & 22
Replacing the connecting pin	19	29
<u>Appendix</u>		
Test card	20	30
Ballistic Data	20	

F O R E W O R D

The design and construction of the new WALTHER sub-machine gun Model MP are based upon decades of practical experience in the development and manufacture of self-loading handguns. Due regard has been paid to the wishes expressed by various authorities, - wishes necessitated partly by tactical considerations, - and the practicability of the various demands has been proved eventually in actual performance. The WALTHER MP is available in two sizes, i. e. Model MP long and Model MP short, and incorporates the following advantageous properties:-

Steady holding during firing. despite the moderate weight.

Design of the sighting devices completely new.

Open coarse sights as well as aperture sights. An optical light - point aiming device for shooting in twilight or at night can be mounted additionally at any time.

Folding stock to fit right-handed and left-handed shooters.

Safety to suit right-handed and left-handed shooters.

Loading through can be carried out readily while the weapon is made safe.

Cocking knob remains stationary, but may readily interlocked with the bolt. This is important, since the weapon can be rendered functional again in any instance of clogging with dirt.

Bolt safety device becomes effective automatically if during cocking the hand should inadvertently lose its hold on the cocking knob.

Component parts are made so as to be readily interchangeable.

Simple in manipulation and operation.

To clean, the weapon may be readily dismantled by means of a few manipulations without causing any parts to fall out.

INDEX TO ILLUSTRATIONS

Page	Illustration	
5	1	WALTHER - MP Cal. 9x19mm, with folded-up stock, magazine inserted; long model.
5	2	WALTHER - MP Cal. 9x19mm, with folded-up stock, magazine inserted; short model.
8	3	Layout diagram.
9	4	Arrangement of coarse and precision sights.
10	5	Arrangement of action and trigger mechanism.
11	6	Applying the safety device.
11	7a	Change-over from "Safe" to "Automatic Fire"
11	7b	Change-over from "Safe" to "Single Shot"
11	8	Extending the folding stock
11	9	Folding the stock.
12	10	Filling the magazine
12	11	Inserting the magazine.
12	12	Cocking the action (bolt).
13	13	Bolt safety device.
13	14	Shooting
13	15	Charge of magazines.
14	16	Un-cocking the action.
14	17	Shooting with blank ammunition
14	18	;Shake-through; operation to clear action.
15	19	Connecting pin: - depressing the locking spring.
15	20	Withdrawing the connecting pin.
15/19	21	Lifting the action body, and/or replacing.
15/19	22	Removing the action body upward and forward, and/or re-mounting the action body.
16/18	23	Withdrawing the bolt unit to rearward, and/or re-inserting the bolt unit.
16	24	Spring guide rod: - depressing the locking spring
16/18	25	Removing and/or inserting the spring guide rod.
16	26	Barrel: - depressing the locking pawl, unscrewing the barrel locking nut.
16/18	27	Removing and/or re-inserting the barrel.
17	28	Survey of dismantled parts.
19	29	Inserting the connecting pin.
20	30	Test Card.

The WALTHER sub-machine gun Cal. 9 mm x 19 with folded stock and inserted magazine, but without carrying sling.

Illustration 1

long model

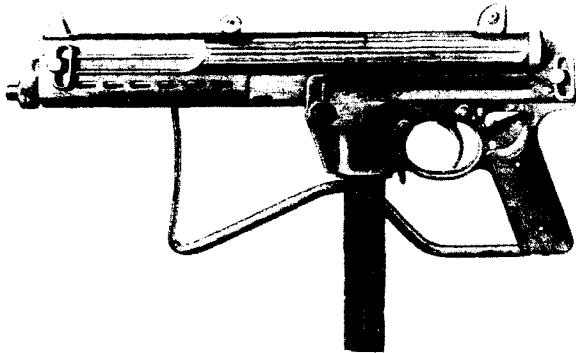

short model

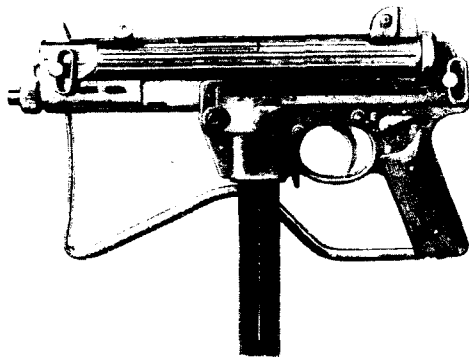

Illustration 2

TECHNICAL DATA

WALTHER sub-machine gun
9 mm x 19
Long Model Short Model

Rate of fire (in rounds/min.)	approx. 550	approx. 550
Weight of MP without magazine	approx. 3 kg	approx. 2.8 kg
Weight of empty magazine	approx. 0.2 kg	approx. 0.2 kg
Weight of full magazine (32 rounds)	approx. 0.625 kg	approx. 0.625 kg
Length, folding stock extended	746 mm	659 mm
Length, stock folded up	460 mm	373 mm
Distance between butt and trigger	385 mm	385 mm
Height of MP	215 mm	215 mm
Length of sight base	357 mm	270 mm
Length of barrel	260 mm	173 mm
Cartridge	9 mm x 19 (Parabellum)	9 mm x 19 (Parabellum)
Dimensions of packing case	47x26x75 mm	47x26x75 mm
Accessories: -	1 Magazine	1 Magazine
	carrying sling	carrying sling
	Device for firing blank ammunition	Device for firing blank ammunition
	Test card	Test card
	Servicing and Operation Manual	Servicing and Operation Manual
Weight of packing material, packing case, 1 MP, 1 magazine, and accessories	approx. 4.20 kg	approx. 4.20 kg

SPECIAL CHARACTERISTICS COMMON TO BOTH MODELS

- Double Sights:** Coarse open Sights
Aperture sights for precision shooting
- Sights:** The MP is regulated (zeroed) at source at 75 m for both the open and the aperture sights. The rear sight can be adjusted.
- Safety:** Double-sided, to suit right-handed and left-handed shooters alike. The safety lever can be set for: "Safe" (at "S"), "Automatic Fire", i. e., continuous fire or short bursts (at "D"), and "Single Shot" (at "E")
The MP may be cocked while the safety is applied.
- Bolt arrester safety:** In order to avoid an unintended discharge caused by either a knock or a fall or else by prematurely releasing the cocking knob and thus letting the bolt rush forward inadvertently if the knob should slip out of the hand, an arresting device is built in which automatically intercepts the bolt.
- Cocking knob:** This knob remains stationary during shooting and automatically returns to its forward position after every cocking operation carried out by hand.
- "Shake-through" manipulation:** The cocking knob can be interlocked with the bolt by pushing the knob firmly against the bolt. The bolt unit may then be actuated forcibly. The cocking knob returns forward automatically when released by the hand.
- Folding stock:** For right-handed and left-handed shooters. Folds flat against the side of the weapon when not in use and is securely locked in position when extended.
- Magazine well:** Splayed rim, to facilitate insertion of magazin even in darkness.
- Magazine:** Holds 32 cartridges in two rows and is particularly indifferent to sand and mud.
- Dismantling of the MP for cleaning:** To effect easy and speedy cleaning, the MP may readily be dismantled without the aid of any tools. The pin connecting the action body with frame is safely held by the latter and cannot be lost.
- Shooting with blank ammunition:** To shoot with blank ammunition, the barrel nut is removed and replaced by the cap provided for partly covering the muzzle.

LAYOUT DIAGRAM

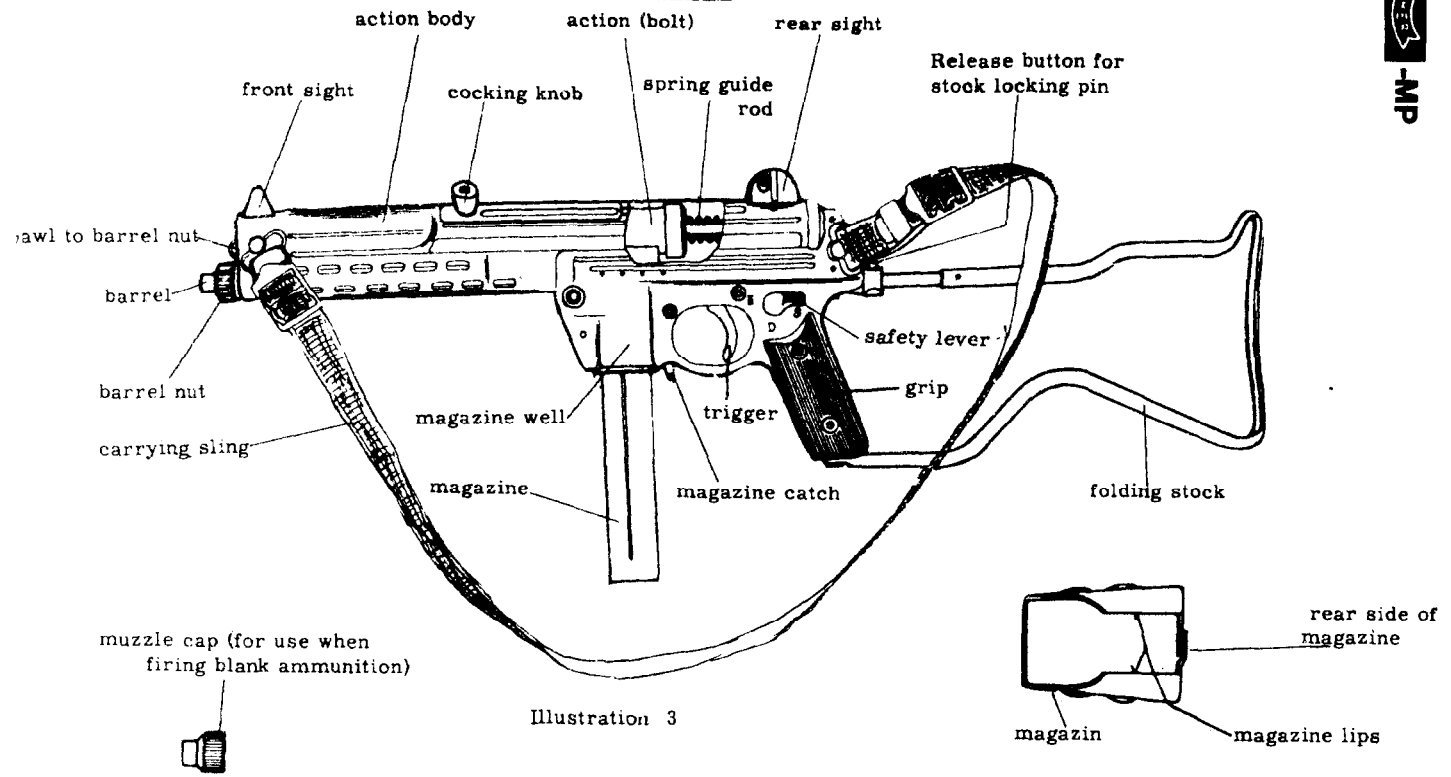

Illustration 3

ARRANGEMENT OF COARSE OPEN AND
PRECISION SIGHTS

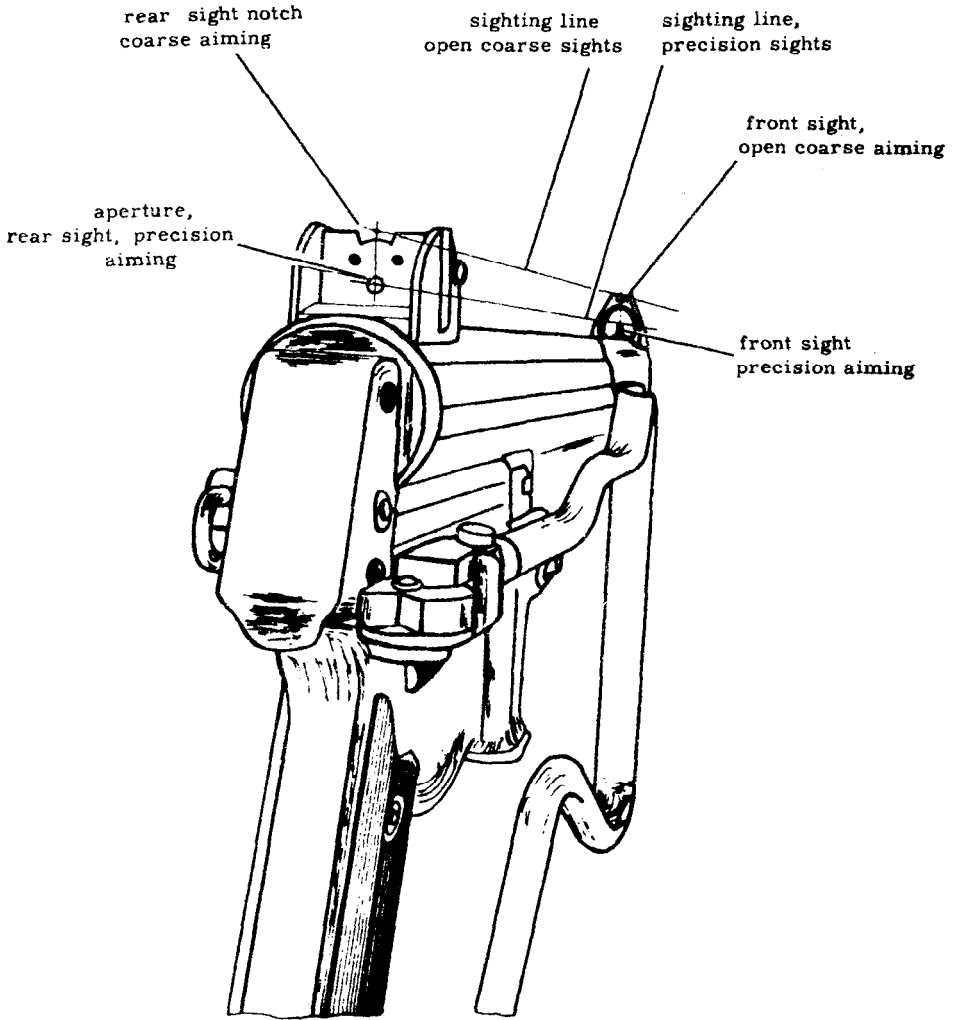

Illustration 4

Arrangement of Action and Trigger Mechanism

The MP, rendered safe, full magazine inserted, action cocked

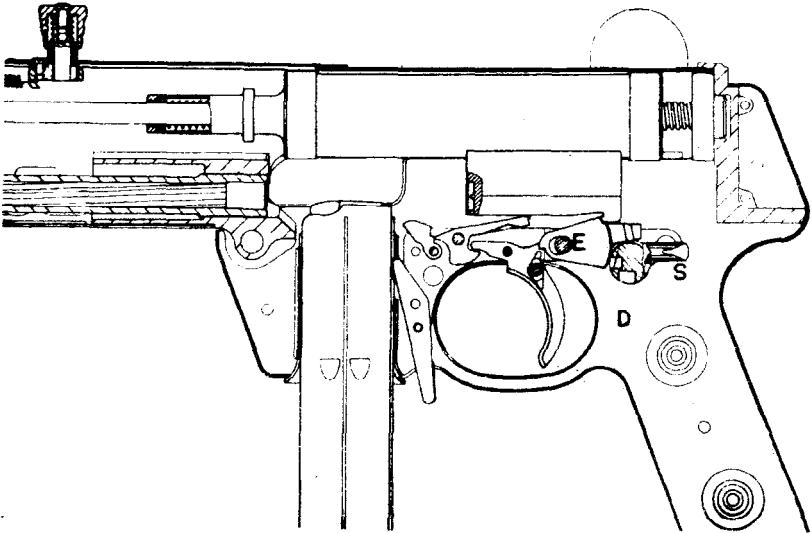

Illustration 5

OPERATION

Prefatory Notice: -

To avoid accidents, always regard the MP as being loaded.

Before handling the MP, always apply the safety first.

Whenever handling or manipulating the MP, always hold the weapon in such way as to cause the muzzle to point forward and downward.

Before dismantling the MP, always make sure that there is no live round in the chamber.

Applying the safety:

Turn the safety lever until it comes to rest at "S" and snaps firmly home. The "S" remains fully visible.

Change-over from "Safe" to "Automatic Fire" or bursts:

Turn the safety lever until it comes to rest at "D" and snaps firmly home. The "D" remains fully visible.

Change-over from "Safe" to "Single shot" (semi-auto):

Turn the safety lever until it comes to rest at "E" and snaps firmly home. The "E" remains fully visible.

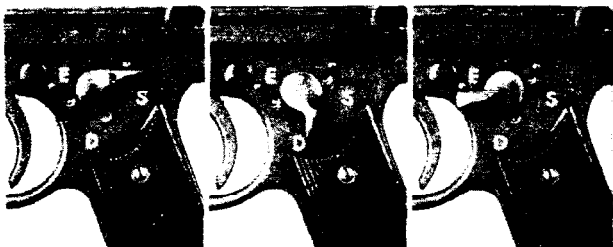

Ill. 6

Ill. 7a

Ill. 7b

Extending the folding stock:

Hold the MP by gripping the action body with the left hand, then unfold the stock and swing the latter fully backwards so as to let the stock locking pin become firmly engaged. The folding stock is thus locked when fully extended.



Ill. 8

Folding the stock:

Hold the MP by gripping the action body with the left hand, grip the stock with the right hand at a short distance behind the hinge, then press the release button down with the right thumb and turn the stock to allow the lock to disengage. Now let the right hand grip the stock nearer the end and fold it up forward against the weapon.



Ill. 9

Filling the magazine:

Hold the magazine with the left hand (back of the magazine turned towards the palm), and feed the cartridges one by one between the lips of the magazine from above. The right thumb pushes the round into the magazine by overcoming the pressure of the magazine spring, at the same time pushing the round backwards until it touches the rear magazine wall.

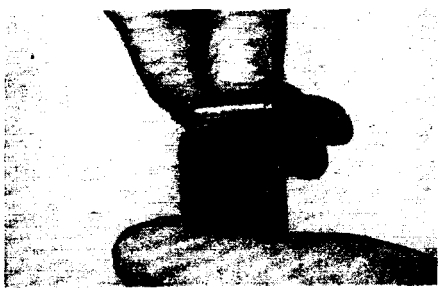

III. 10

Emptying the magazine:

The left hand grips the magazine in the same manner as for filling. The right thumb then pushes each round forward and out.

Preparing to shoot:

Apply the safety catch (at "S") and hang the MP over the shoulder by the carrying sling.

Firing positions:

From the hip while the stock is folded up, or from either the hip or the shoulder while the stock is extended.

Inserting the magazine:

Hold the MP by the grip with the right hand. The left hand holds the filled magazine (with the back of the latter turned towards the palm) and pushes it into the magazine well by overcoming the tension of the magazine spring until the magazine catch engages and holds the magazine. Pull magazine downwards to ensure that the magazine is firmly held in the well.



III. 11

Cocking the action:

Grip the cocking knob with thumb and index finger and pull it fully backwards to the limit of its travel, thereby cocking the bolt. The bolt itself is held by the sear. When released, the cocking knob automatically returns to its forward resting position.

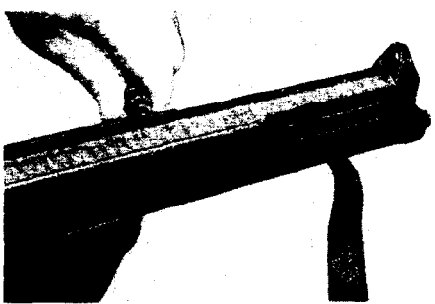

III. 12

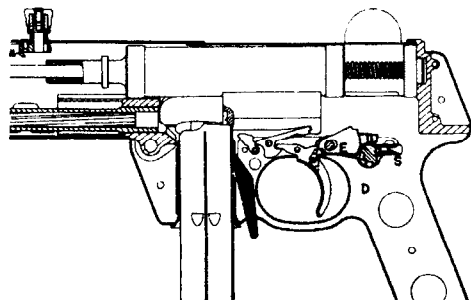

Ill. 13

Bolt safety device:

In any instance in which the hand happens to slip off the cocking knob before the bolt has been retained by the sear but after the front edge of the bolt has already reached a position behind the base of the cartridge, the bolt is caught by the bolt arrester safety device. The latter also becomes effective if the MP is either dropped or else receives a blow whereby the bolt might be thrown backwards.

Shooting:

Raise the MP to the firing position. The right hand holds the grip, the left hand moves the safety lever to either "D" (= "automatic fire" and/or "bursts") or "E" (= "single shot"). The left hand then grips the magazine immediately below the magazine well. The right index finger may now touch the trigger for aimed shots, use either the coarse open sights or else the (lower) aperture sights.



Ill. 14 (without the sling)

Continuous fire: (Automatic fire)

Pull the trigger through and retain until the magazine is empty. At the end of such continuous firing, the action will be found to be uncocked.

Bursts:

Pull the trigger and release it again after firing short bursts. The number of shots fired depends upon the duration of the periods for which the trigger is pulled. When firing bursts, the action remains cocked after each short burst. If the magazine becomes empty whilst bursts are being fired, the action may be found to be either cocked or else uncocked.

Single shots: (Semi-automatic fire)

Pull the trigger. The bolt is retained by the sear after every shot. The next shot can be fired only after the trigger has been allowed to return forward, after which it may be pulled again. The action is always cocked after firing single shots.

Change of magazines:

Apply the safety, at "S", thus rendering the MP safe. Press the magazine catch fully forward with the left thumb and withdraw the magazine from the magazine well, then insert the full magazine. (See "Inserting the magazine", page 12)



Ill. 15

Un-cocking the action:

Render the MP safe (safety lever to "S"), remove the magazine, look into the ejector opening to make sure that the chamber is empty, then turn the safety lever to "D". Pull the cocking knob back to its fullest extent of travel with the left index finger and thumb, hold firmly in this position pull the trigger, and allow the knob to return slowly forward together with the bolt by retaining the hold on the cocking knob, then render the MP safe again.

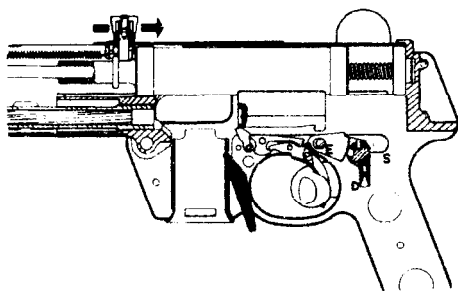

Ill. 16

Shooting with blank ammunition:

Render the MP safe, depress the pawl unlock the barrel nut, unscrew the latter, and replace it with the muzzle cap. Screw the latter home and allow the pawl to engage (to avoid loss). Fill the magazine with blank cartridges Cal. 9 mm. Insert the full magazine in the magazine well, cock the action, and move the safety lever to either "D" or "E". The MP is now ready for use.

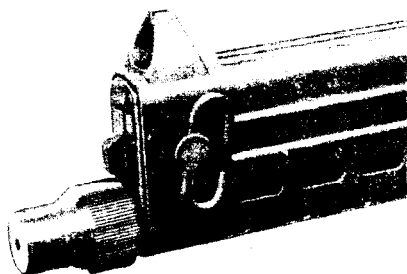

Ill. 17

"Shake-through": (to clear the action)

Should the action become clogged up with dirt, mud, or similar matter and thus cease to function properly, the action mechanism can in such case be rendered freely operative again by pulling the cocking knob back and at the same time pushing the knob on to the bolt, thereby interlocking the knob with the bolt, To "shake-through" proceed as follows:

Render the MP safe, remove the magazine, look into the ejector opening to make sure that the chamber is empty. Interlock the cocking knob with the bolt by pulling the knob backwards and at the same time pushing the knob on to the bolt and holding the latter there, then move the safety lever to "D" ("Automatic fire"), pull the trigger, and move the cocking knob backward and forward repeatedly whilst pressing the knob against the bolt. Release the trigger and move the safety lever to "S". Cock the action, insert a full magazine, move the safety lever to either "D" or "E". The MP is now ready for use again.

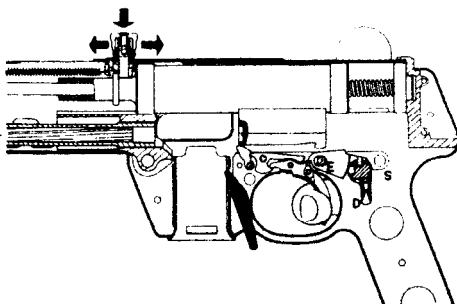

Ill. 18

Dismantling the MP for cleaning

Preparing to dismantle:

Render the MP safe, remove the magazine, unload by cocking the action. Look into the ejector opening to make sure that the chamber is empty. Move safety lever from "S" to "D", uncock the action (see page 14), then render the MP safe again.

Removing the connecting pin:

The left hand holds the MP by the action body. The right thumb first presses the locking spring on the connecting pin and then the latter itself. Next, the left hand holds the MP by the grip, while the left hand withdraws the connecting pin downwards on the opposite side.



III. 19



III. 20

Dismantling the action body:

The action body and the connecting pin are held in an oblique position. Lift the action body with the left hand and remove it forward. Lay the frame (grip unit) aside.

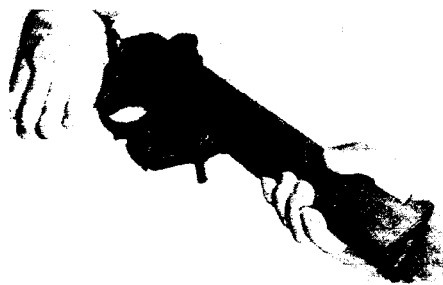

III. 21

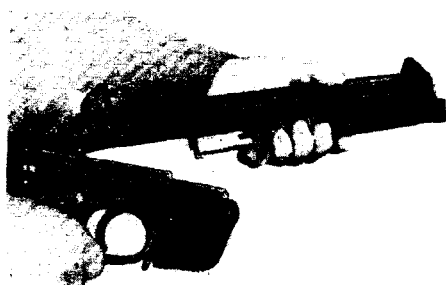

III. 22

Dismantling the action: (bolt)

Remove the bolt unit by pulling it out of the action body to the rear. Lay the action body aside.

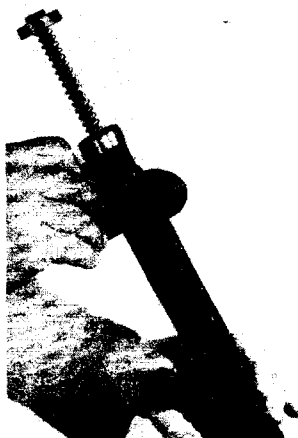

III. 23

Dismantling the spring guide rod:

Hold the bolt unit with the left hand and let the thinner cylinder end point obliquely downward. Press the safety spring at the end of the spring guide rod inwards with the right thumb. The spring guide rod jumps back a short distance and may now be withdrawn from the bolt with the right hand.

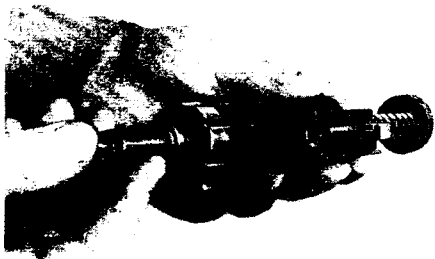

III. 24

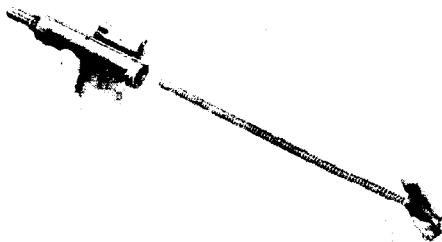

III. 25

Dismantling the barrel:

The left hand grips the action body well forward. The left index finger presses the pawl inwards. Thumb and index finger of the right hand unscrew the barrel nut. Lay the latter aside and withdraw the barrel from the action body.



III. 26

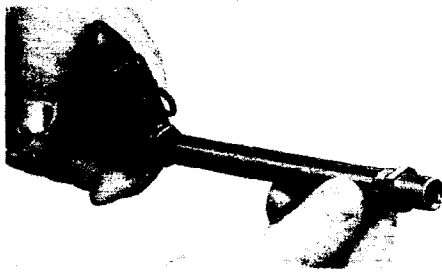

III. 27

View of the dismantled parts

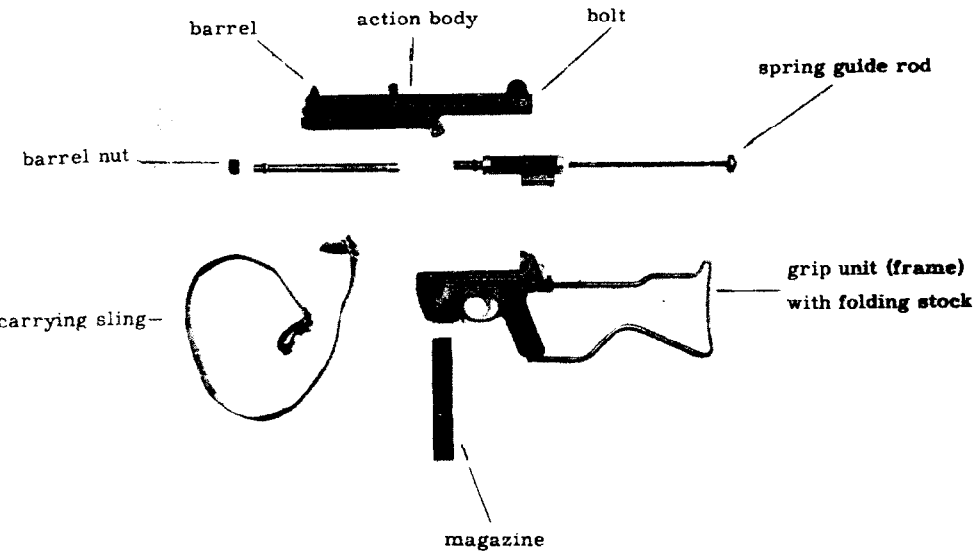

Ill. 28

Cleaning:

For normal cleaning, it is sufficient to dismantle the MP to the extent as shown in Illustration 28. Further dismantling may be carried out only in the event of excessive fouling, and then only by qualified artisans.

Cleaning of the MP is carried out by means of the appropriate cleaning equipment.

After cleaning the MP, lubricate lightly with a suitable oil.

Assembling the dismantled components

Prefatory note relating to assembly:

Assembling of the MP is carried out in the opposite order so that as applied to dismantling. Manipulation is thus similar.

Mounting the barrel:

When inserting the barrel into the action body, ensure that the flat portion of the collar at the muzzle end of the barrel comes to rest under the flat side of the lip at the threaded nipple at the front of the action body. Push the pawl inward, screw the barrel nut fully home, and allow the pawl to engage.

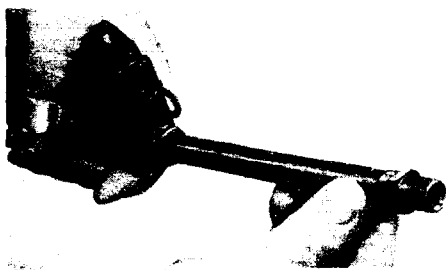

Assembling the spring guide rod:

Insert the spring guide rod in the wider bore of the bolt and push through far enough to enable the safety spring at the end of the spring guide rod to rest on the front end of the tubular extension of the bolt.

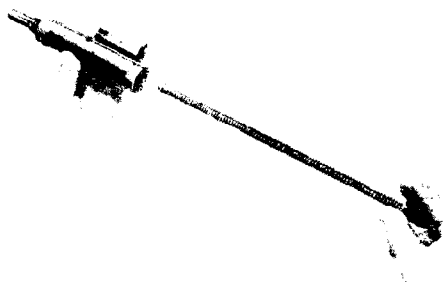

Assembling the bolt unit:

The left hand holds the action body, while the right hand introduces the assembled bolt and spring guide rod unit into the action body, pushing the unit into the latter until the bolt comes to rest against the chamber. To carry out this operation, the action body is held obliquely downward.

III. 25

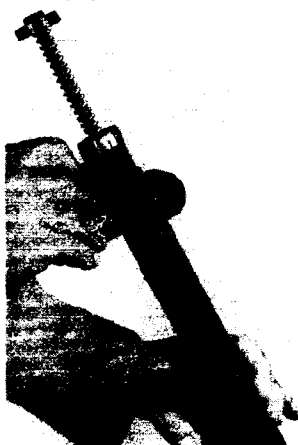

Assembling the MP - mounting the action body:

The right hand holds the MP by the grip thus that the connecting pin protrudes downward as far as the retaining collar will allow. The left hand inserts the rear end of the action body in such way as to enable the boss at the rear end of the spring guide rod to fit into the circular recess in the abutment at the rear of the grip (frame) unit, and pushes the spring guide rod in until the action body fits snugly onto the grip (frame) unit. The left hand then tilts the action body with the action and the lug on the chamber fully down between the two side walls of the frame. The action body is held in this position by the action of the spring on the spring guide rod.

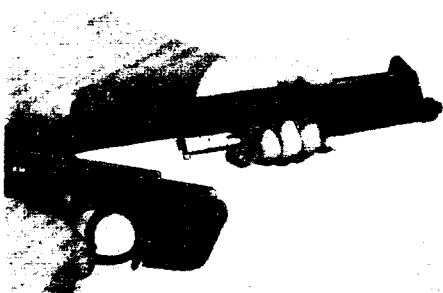

III. 22

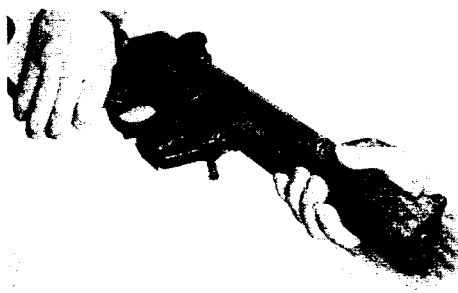

III. 21

Replacing the connecting pin:

Place the butt of the extended folding stock against the hip thus that the connecting pin points upwards. The left hand grips the front end of the action body and pushes this against the stop on the grip unit. The right hand grips the action body to the rear of the connecting pin and pushes the latter fully home until the safety spring on the opposite side engages.

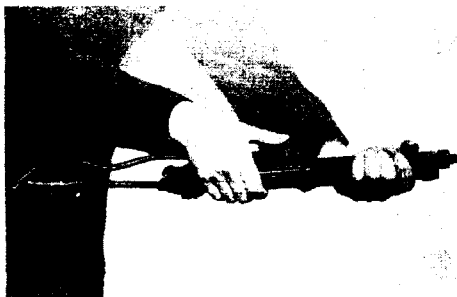

III 29



Test card

Circular area of 300 mm diameter
 Shot pattern at a distance of 75 m
 Number of shots fired: 5 m
 Sighting range: 75 m

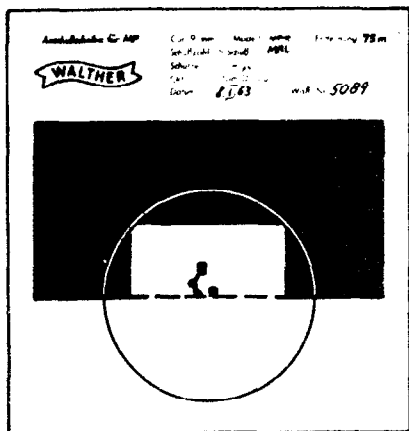

Ill. 30

Ballistic Data

Cartridge: - 9 mm x 19 (Parabellum)
 Bullet weight: - 8 g
 Powder charge:- 0.345 g
 Pressure :- 2400 kg/cm²
 Muzzle velocity: - 350 m/s
 Muzzle energy:- 50 mkg
 Extreme range of fire:- 1600 m
 Safety limit in direction of fire 2000 m
 Safety limit on either side of the firing line:- 1000 m

Penetration of individual shots:-

Material	Distance		
	25 m	50 m	200 m
Lose soil	36 cm	35 cm	31 cm
Sand	26 cm	25 cm	21 cm
Pine	23 cm	23 cm	17 cm
Sheet steel, 2 mm thick hit at an angle of 90°	Perforation		Perforation